



UGANDA SECONDARY SCHOOLS SPORTS ASSOCIATION

GNS Plaza, 2nd floor, Old Kampala Road

P.O Box 114052 - Kampala, Uganda

ussaonline.com | Email: ussa2002@gmail.com

Tel: +256 393 256 054

January 19, 2024

ATTENTION:

School Sports Stakeholders,

RE: COMPETITION FORMATS FOR 2024 CHAMPIONSHIPS

In reference to the above subject,

All Secondary School Games (District, Zone and National) Championships shall be played in accordance to **USSSA Rules and Regulations Article 12 Section (i), (ii) and (v)**. The play formats shall be used across all sports disciplines and all age category games International sports laws of various sports disciplines shall be used and the time/duration of the games shall be agreed on by the organizers in relation to the international standards and governing bodies.

THE DAYS OF THE CHAMPIONSHIP WILL BE AS FOLLOWS

NO	CHAMPIONSHIP	DATES	NO. OF DAYS	HOST SCHOOL
1	National Football Boys Championship	26 th April – 05 th May, 2024	9 Days	Masaka Sec School
2	Fresh Diary Secondary School Games	26 th April -05 th May, 2024	9 Days	Ndejje S School
3	National Secondary Sch Swimming Gala	27 th - 30 th May 2024	3 Days	Seroma Christ High Sch
4	National Secondary School Ball Games II	9 th - 18 th July, 2024	9 Days	Teso College Aloet
5	FEASSSA Games	19 th - 31 st August, 2024	11 Days	Bukedea Comprehensive School



Find us on socials:



MODE OF PLAY,

1. Teams will be grouped in 16 Groups composed of 4 Teams each **Group (64 Teams)** where there are 64 teams.
2. Top 2 teams in a group proceed to the round of **32 (Rank 1-32)**
 - a. Bottom 2 teams will play round of **32** and be grouped as follows
 - b. Teams ranked number 3 in a group will progress to round of 16 as per their category (**ranked 33-48**)
3. Teams ranked number 4 in a group will also progress to round of 16 as per their category ranked (**49-64**)

Above will be repeated to quarter finals, semi-finals and finals and will apply to all other disciplines.

Attached are the Flow Charts for the Championships depending on the Number of Teams in a particular Sports Discipline.

"I wish you the best in Organization and Management of School Sports"

I remain available for inquires

Yours faithfully,



Mugisha Christopher Banage

Chief Executive Officer (CEO)

Copy to: President ASSHU
General Secretary ASSHU
Regional Chairpersons ASSHU
District Chairpersons ASSHU
District Sports Officers (DSO)
Executive Committee
All Secondary School

UGANDA SECONDARY SCHOOLS SPORTS ASSOCIATION (USSSA) COMPETITION FLOW CHART

GROUPS	RNK	ROUND OF 32		ROUND OF 16		QUARTER FINALS		SEMI FINALS	FINALS
		NAME OF SCHOOL	SCORES	NAME OF SCHOOL	SCORES	NAME OF SCHOOL	SCORES	SCORES	
GROUP A	1	NAME OF SCHOOL	3	NAME OF SCHOOL					
GROUP B	16	NAME OF SCHOOL	1						
GROUP C	8	NAME OF SCHOOL	2	NAME OF SCHOOL					
GROUP D	9	NAME OF SCHOOL	4						
GROUP E	5	NAME OF SCHOOL		NAME OF SCHOOL					
GROUP F	12	NAME OF SCHOOL							
GROUP G	4	NAME OF SCHOOL		NAME OF SCHOOL					
GROUP H	13	NAME OF SCHOOL							
GROUP I	6	NAME OF SCHOOL		NAME OF SCHOOL					
GROUP J	11	NAME OF SCHOOL							
GROUP K	3	NAME OF SCHOOL		NAME OF SCHOOL					
GROUP L	14	NAME OF SCHOOL							
GROUP M	7	NAME OF SCHOOL		NAME OF SCHOOL					
GROUP N	10	NAME OF SCHOOL							
GROUP O	2	NAME OF SCHOOL		NAME OF SCHOOL					
GROUP P	15	NAME OF SCHOOL							

[Handwritten Signature]

FLOW CHART FOR 8 GROUPS

RANKING ROUND 16 QUARTERS SEMI-FINALS FINALS

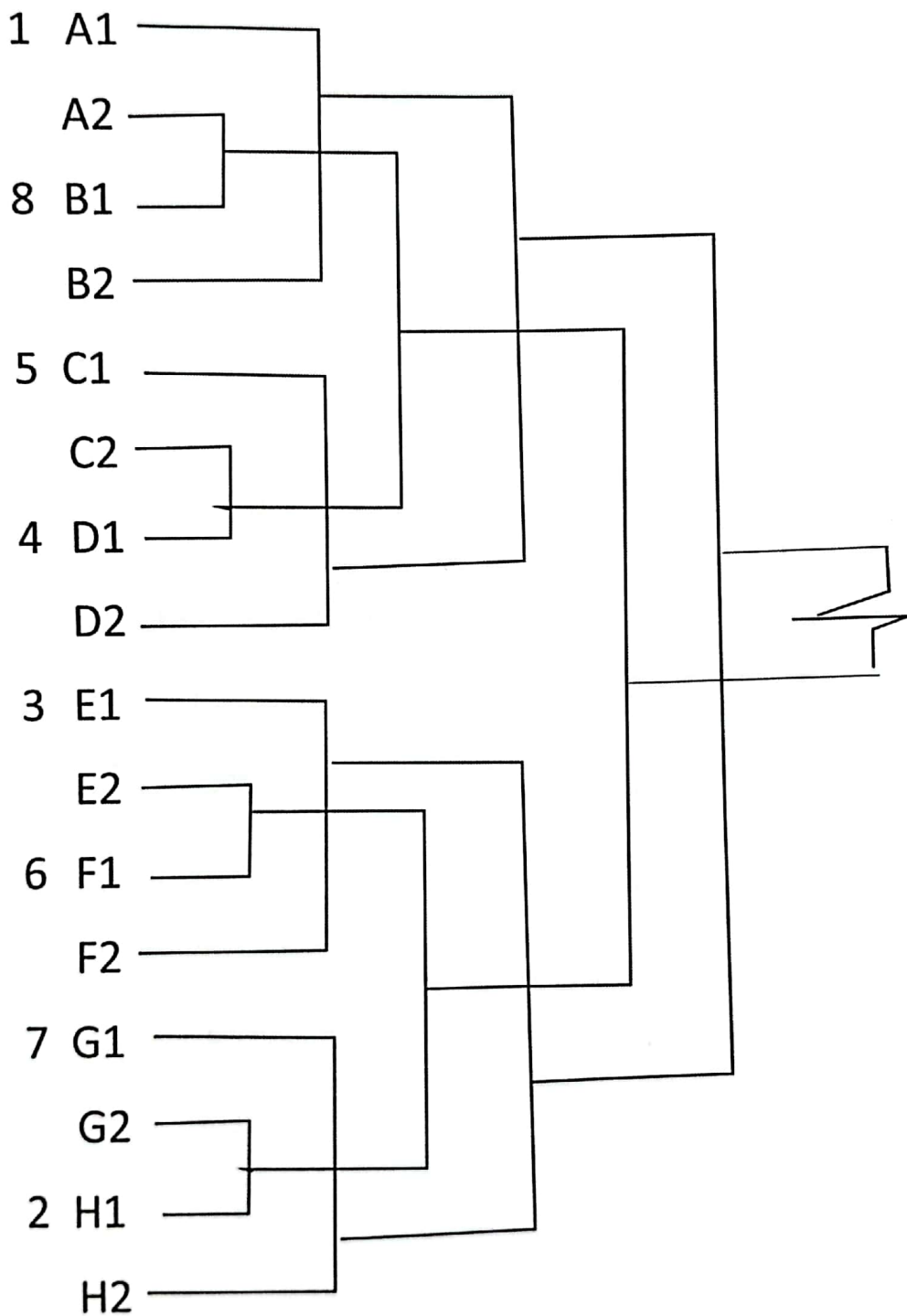

END

[Handwritten signature]

UGANDA SECONDARY SCHOOL SPORTS ASSOCIATION

COMPETITION FLOW CHARTS FOR DIFFERENT GROUPS.

I .FLOW CHART FOR 2 GROUPS

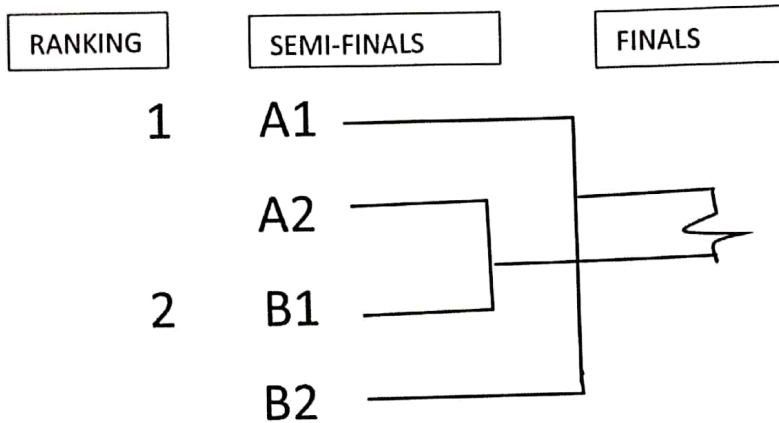

II . FLOW CHART FOR 3 GROUPS

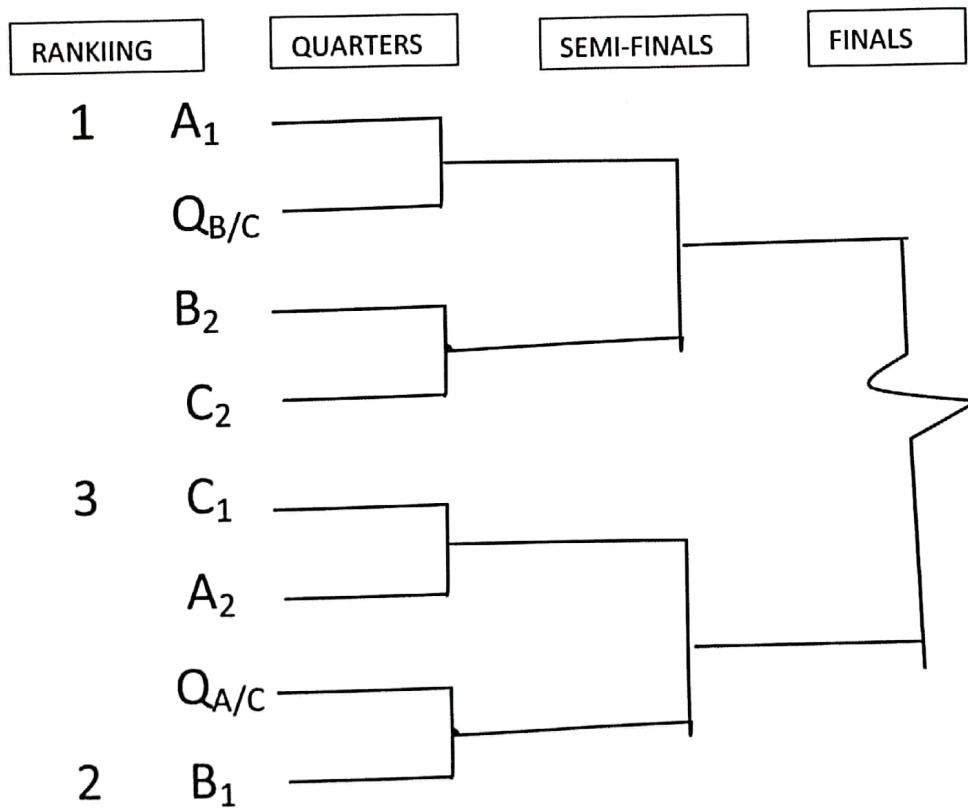

III .FLOW CHART FOR 4 GROUPS

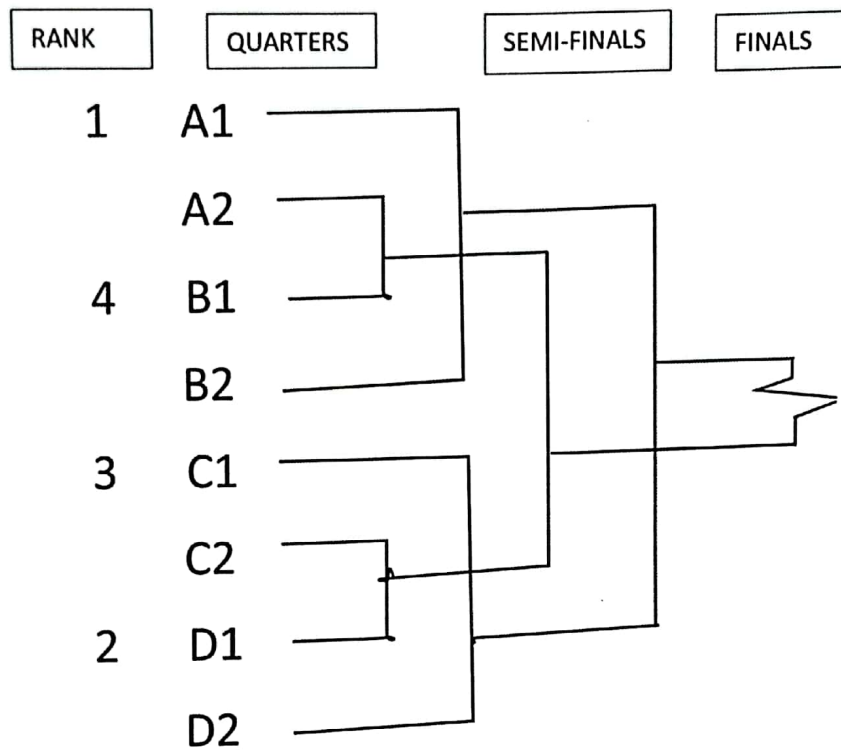

[Handwritten signature]

1V. FLOW CHART FOR 5 GROUPS

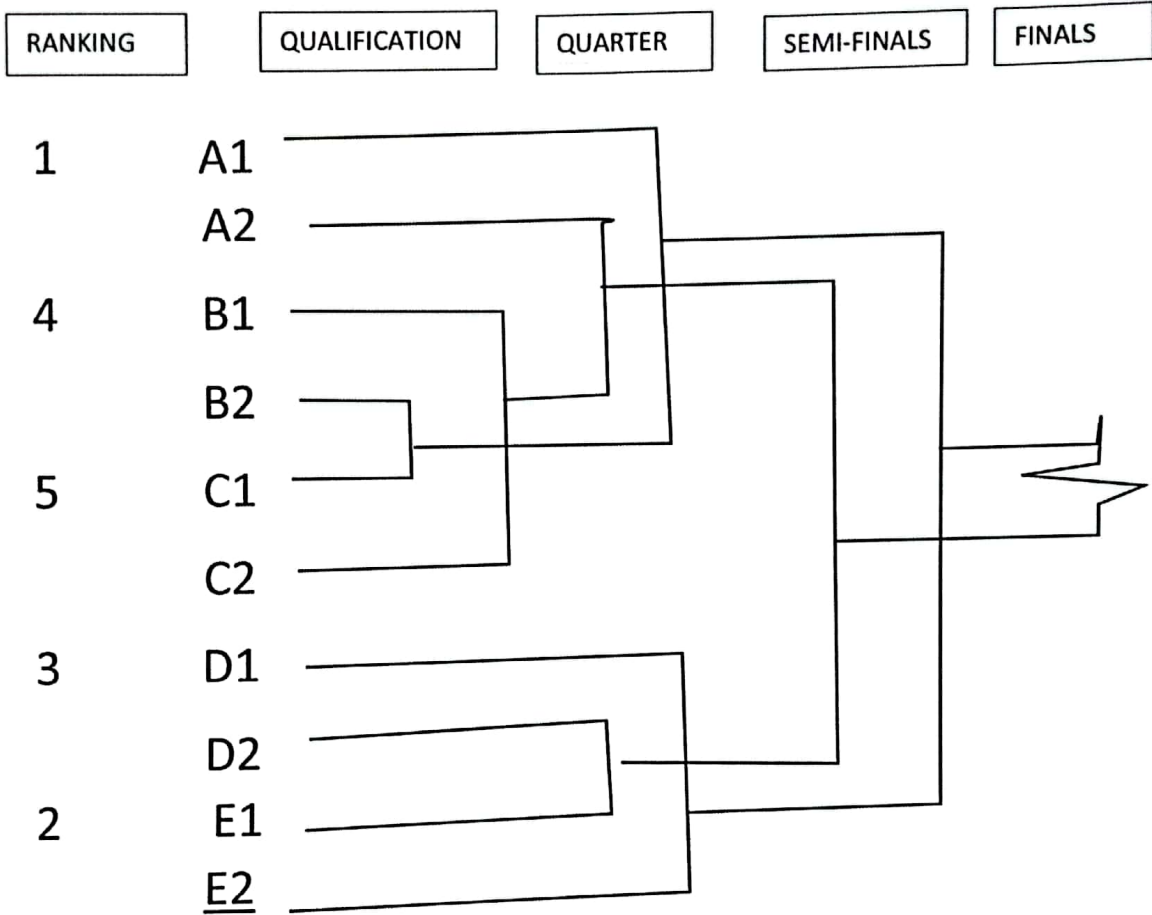

[Handwritten signature]

V(a).FLOW CHART FOR 6 GROUPS

RANKING BYE QUATERS SEMI FINALS

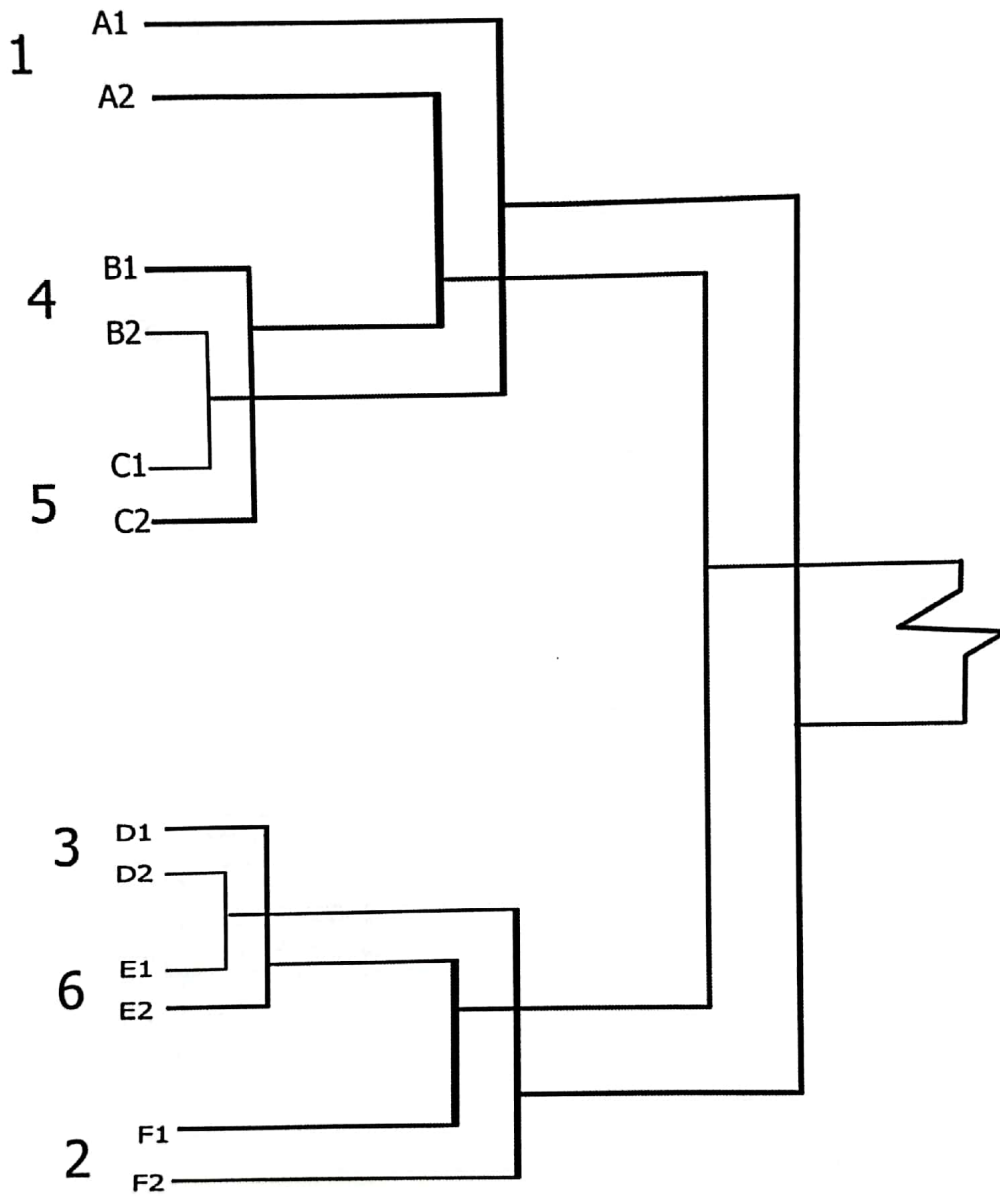

[Handwritten signature]

UGANDA SECONDARY SCHOOLS SPORTS ASSOCIATION FLOW CHART (4 GROUPS) – ROUND OF 16

ROUND 16

QUARTER FINALS

SEMIFINALS

FINALS

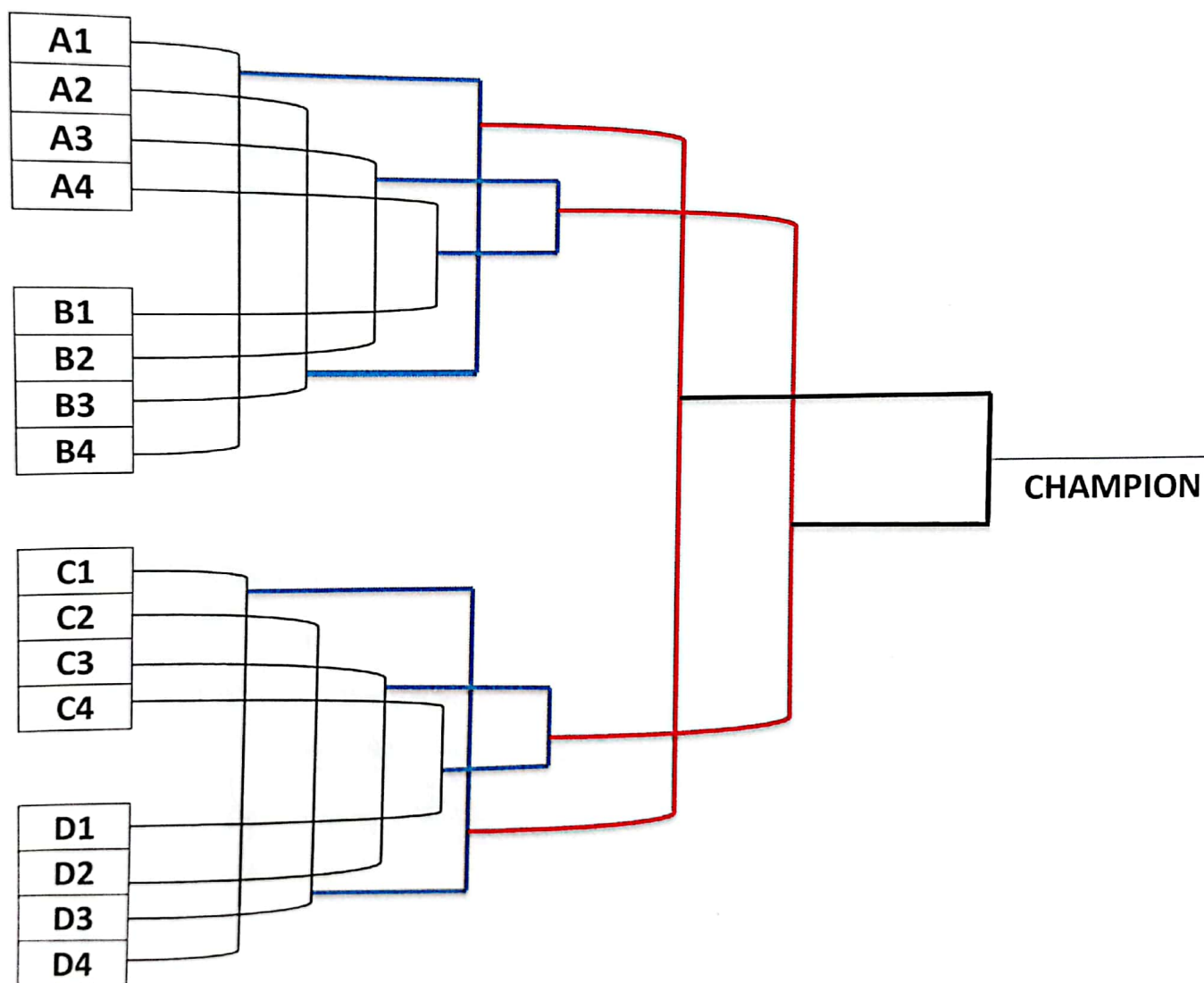

FOR SCHOOL SPORTS FOR BETTER